

Nominal Size H x W x D (in)	Actual Size H x W x D (in)	Part Number	Capacity (CFM)	Resistance (in W.G.)	Media Area (sq ft)	Carton Qty	Weight per Carton (lbs)
24x24x12	23-3/8 x 23-3/8 x 11-1/2	110-788-001	2000	0.52	178	1	29
24x12x12	23-3/8 x 11-3/8 x 11-1/2	110-788-002	1000	0.52	85	2	32
24x20x12	23-3/8 x 19-3/8 x 11-1/2	110-788-003	1650	0.52	141	1	28
20x12x12	19-3/8 x 11-3/8 x 11-1/2	110-788-014	833	0.52	70	1	24
20x16x12	19-3/8 x 15-3/8 x 11-1/2	110-788-004	1100	0.52	94	1	26
24x24x6	23-3/8 x 23-3/8 x 5-7/8	110-788-009	1000	0.52	88	2	30
24x12x6	23-3/8 x 11-3/8 x 5-7/8	110-788-010	500	0.52	43	4	31
20x20x6	19-3/8 x 19-3/8 x 5-7/8	110-788-013	700	0.52	61	2	27

**Standard Construction:**

1. Gradient Density Microfiberglass Media
2. Frame: 26 GA Aluminized Cellsides
3. Media Separators: Corrugated Aluminum with hemmed safety edge
4. Header Depth: 13/16" Standard
5. Header on Upstream Side of filter
6. Insert on Upstream Side of filter
7. Aluminized Faceguards on U/S and D/S side of filter.

**Specifications**

1. Efficiency: MERV 11 ( 60-65% ) ( ASHRAE Std 52.2-2017 )
2. Temperature Rating: 900F
3. Initial Resistance: .60" W.G.
4. Final Resistance: 1.20" W.G.
5. Classified per UL Standard 900
6. Tolerance: Height & Width - +/- 1/8"
7. Tolerance: Depth - +/- 1/16"

**Notes:**

1. All dimensions are in inches unless otherwise noted
2. Drawing "Not To Scale"

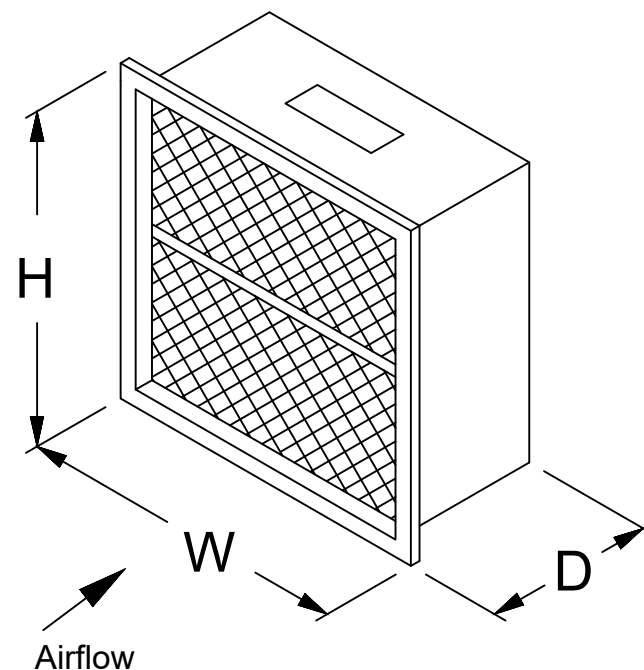

	<b>Multi-Cell HT MERV 11 Single Header</b>	REV	REVISION	BY / DATE
		LTR		
8401 Air Commerce Drive - Louisville KY 40219 Phone: (502) 634-4796 FAX: (502) 637-2280	Drawn By: B. Chamberlain Date: May 30, 2023	Revision		